

FG-7000TA Digital Torque Gauge



Operation Manual



Warning

Operators should wear protection such as a mask and gloves in case pieces or components break away from the unit under test.

Whether the unit is ON or OFF, DO NOT exceed the capacity of the sensor. NEVER exceed 120% of the rated capacity, or the torque sensor will be damaged. At 110% of the rated capacity the display will flash a warning.

If mounting FG-7000T Series Digital Torque Gauges, use M4 mounting screws with a maximum insertion depth of 7 mm into the gauge. Hand tightens mounting screws, DO NOT use tools. Do not use damaged clamp.

Measure in line torque only. DO NOT attempt to measure forces at an angle to the sensor – damage to sensor may result.

Do not attempt to repair or alter this instrument. Warranty will be voided and damage to the unit may result.

Use and store within the stated temperature and humidity ranges, or damage and failure may result.

If not using this instrument for extended periods of time, remove the batteries to prevent potential battery leakage from causing product damage.

DO NOT use tools to over torque the connection adapter. Hand-tighten only so damage does not occur.



The FG-7000TA Series digital torque gauges provide testing flexibility with their external torque sensor input. Torque sensors with the adjustable clamp adapter are immediately recognized when connected to the display base. Units are available for your specific testing needs in 1 N-m (9 in-lb) 5 N-m (44 in-lb) & 10 N-m (88 in-lb) capacities. The adjustable clamping mechanism enables flexible test size operation from approximately 0.56 to 2" (14 to 50 mm) diameters. Four selectable modes of operation include: Track mode for live readings, Peak mode for displaying the maximum reading, First Peak where only the initial peak is recorded once a decrease is sensed and Preset which initiates user-programmed tolerance alarms for go/no go testing. The display has two selectable operations, numerical view with directional bar graph or graphical view with directional bar graph. In graphical view when alarm tolerances are set, the process is plotted in relation to the upper and lower limit graph lines. Combined with the go/no go icons, a simple pass/fail determination is recognized. These high-tech instruments can data log a reading at the push of a button for simple data acquisition or be set to continuous data storage. Data can be viewed on the screen, sent to the optional printer, or loaded to be analyzed and graphed on the free software program. The 1,000 point memory with definable groups allows for multiple tests to be recorded and easily separated upon loading. In addition, the comparator output can be set up for integration of the instrument into a quality system for repetitive testing such as on a production line. The large back-lit, 180° auto-reversible display, CW/CCW directional bar graph, combined with the dual labeled key pad allows for usage of the gauge in various positions while still being able to easily view and operate. These various features make the FG-7000T the ideal torque instrument for various applications such as closing or opening analysis of containers, valves and door hardware, failure or destructive torque testing, or almost any torque testing requirement involving incoming quality inspection, finished goods testing to R&D.

SPECIFICATIONS

Accuracy: $\pm 0.3\%$ F.S.

Selectable Units: N-m, N-cm, kgf-cm, lbf-in (Depending on Range)

Overload Capacity: 120% of F.S. (LCD flashes beyond 110% of F.S.)

Measurement method: Peak, First Peak Preset or Track Mode

Data Sampling Rate: 1000 Hz

Display: 160*128 dot matrix LCD with LED Backlight

Display Update Rate: 10 times/second

Resolution: (See page 2 Resolution Table)

Memory: 1000 data

Set Point: Programmable high and low limits

Battery Indicator: Display flashes battery icon when battery is low

Power: 3.6VDC 800mAH Ni-MH rechargeable batteries

Battery Life: Approximately 16 hours continuous use per full charge

Charger / Adapter: Universal USB/BM charger, Input: 110 ~ 240VAC

Temperature Effects: <0.054% per °F (0.03% FS per °C)

Outputs: USB, Serial Port RS-232, High & Low Limit NPN

Operating Temperature: 14 to 104°F (-10 to 40°C)

Storage Temperature: -4 to 122°F (-20 to 50°C)

Oper. Relative Humidity: 5 to 95%

Storage Relative Humidity: 20 to 80%

Housing: Aluminum

Dimensions: 5.7 x 2.9 x 1.4" (145 x 73 x 35.5 mm)

Product Weight: 3.5 (1.6 kg)

Package Weight: 5.3 (2.4 kg)

Warranty: 1 year

Certification: CE

Included Accessories: AC Adapter/Charger, USB cable, carrying case, calibration cert.

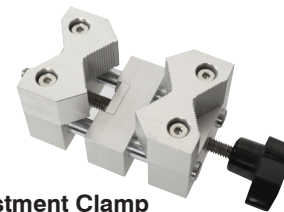

Adjustment Clamp

SEALS USA, Inc.





Instruments Division

Tel: (630)924-7138

Email: support@seals-usa.com



1. LCD SCREEN STANDARD VIEW

Test Mode Icons:



	Track: Real Time, live measuring mode
	Peak: Reading will not change until a higher value is measured
	Preset: Set the upper & lower limit for GO/NG testing
	First Peak: Captures First Peak after a decrease has been detected. Drop Ratio set in menus.

2. Battery Icon: Battery level or charging status. Flashes when gauge needs to be recharged.

3. OK/OV Indicator:

	Under Lower Limit
	Between Low Limit & Upper Limit
	Over Upper Limit

4. Torque Icons: Indicates force direction.

	Clockwise (CW)
	Counterclockwise (CCW)

5. Current measured value

6. Analog Bar: Indicates current position within full scale. When the bar enters the area enclosed by the dotted line, this signifies the full scale capacity is exceeded by an overload condition.

7. Storage Icon: Indicates data is being saved.

8. System time

9. Units Indicator: Selected engineering unit.

10. Load Cell Capacity Icon:

	If no load cell is connected, this symbol appears & blinks
---	--

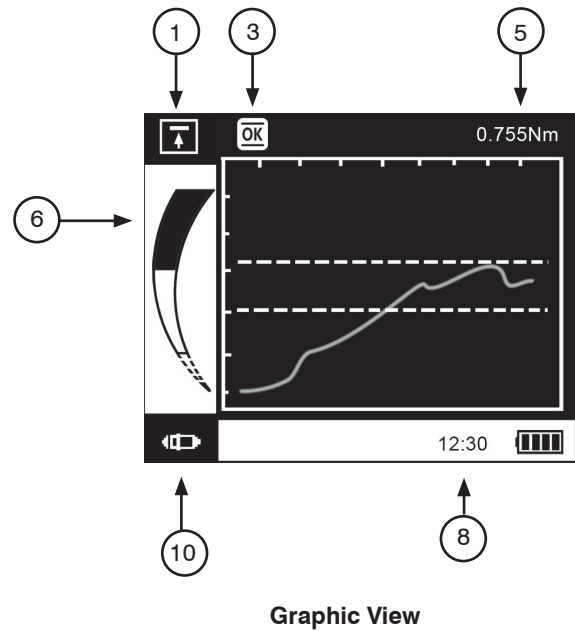
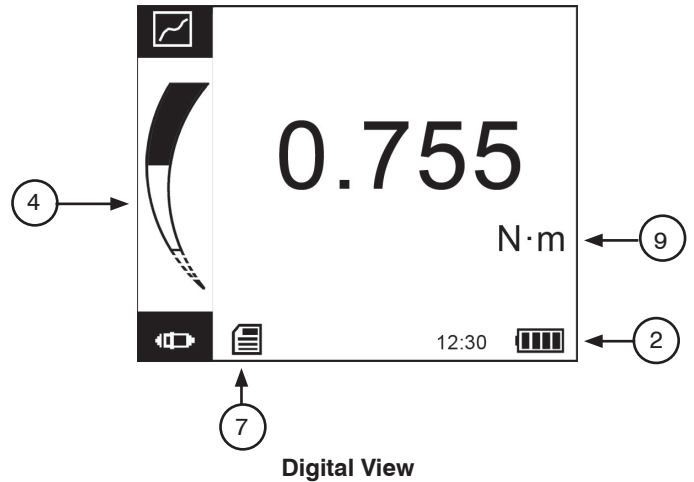





2. RESOLUTION TABLE

Model		N-m	N-cm	kgf-cm	lbf-ft	lbf-in	Interface Type
FG-7000TA-1	Capacity	1	100	10	-	8.9	Adjustable Clamp 14.29 - 50.23 mm (0.56 - 1.98")
	Resolution	0.001	0.1	0.01	-	0.005	
FG-7000TA-2	Capacity	5	500	50	3.68	44.3	
	Resolution	0.001	0.1	0.01	0.001	0.01	
FG-7000TA-3	Capacity	10	1000	100	7.38	88.5	
	Resolution	0.01	1	0.1	0.001	0.01	

3. KEY FUNCTIONS

All keys are capacitive touch.

-  ON/OFF: Push for 2 seconds to power On or Off
-  During Measurement: Print the current force value or store data, depending on the key setting. (See 4.5.8 for key setting)
In Menus: Back or quit.
-  During Measurement: Enter the menus.
In Menus: Select or Enter
-  During Measurement: Track mode, tares weight of attachment. In Peak & Auto Peak modes, resets the peak value.
In Menus: Moves selection up or increases the value.
-  During Measurement: Changes the measure mode from Track, Peak, Auto Peak, First Peak
In Menus: Moves selection down or decreases the value.

4. ADVANCED MENU OPTIONS

4.1 Menu Structure

Menu	Measurement	Unit
		Group
		Test Mode
		Alarm
		Calibration
	Memory	Storage Mode
		Browse All
		Browse Selected
		Delete Selected
		Delete All
	Printing	Print Recent
		Print Selected
		Print All
	System	Display Mode
		Display Direction
		Auto Power Off
		Backlight
		Key Tone
		Date/Time
		Password
		Key Setting
		RS-232 Baud Rate
		Default Setting
Language		
Information		

From the home screen, touch “MENU” to enter the main menu. (Figure 4-1)

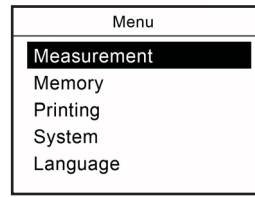

Figure 4-1a

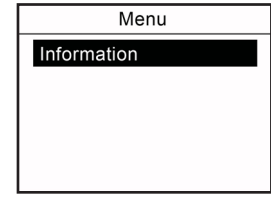

Figure 4-1b

4.2 Measurement

The Measurement menu contains six selectable items: Unit, Group, Test Mode, Alarm and Calibration. (Figure 4-2a)

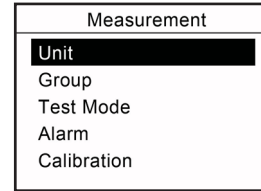

Figure 4-2a

4.2.1 Unit

The measuring unit can be selected under this menu. Different range models may have different unit selection capabilities. Touch “ZERO” or “MENU” keys to shift to the next selection. Press “LOG” to cancel or touch “MENU” to confirm and exit. (Figure 4-2c)

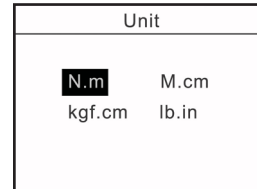

Figure 4-2c

4.2.2 Group

When several test samples need to be measured, the samples can be coded into groups. The range is 01-99. When set to “00”, become, “01” automatically. Press “ZERO” to adjust the value, touch “MODE” to shift to the next position. Touch “LOG” to cancel; press “MENU” to confirm and exit. (Figure 4-2d)

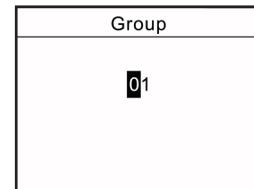

Figure 4-2d

4.2.4 Test Mode

Change the mode of operation between the four modes. Press “ZERO” or “MODE” keys to select. Press “LOG” to cancel or “MENU” to confirm and exit. This adjustment can also be changed at the home screen display by simply pressing “MODE” (Figure 4-2f). First Peak Mode will display a drop ratio recording.

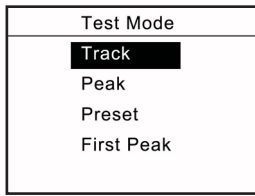

Figure 4-2f

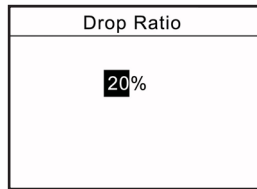

Figure 4-2g

4.2.5 Tolerance

In the Preset menu, program high and low limit values to enable ok/ov testing. The lower limit value cannot be greater than the upper limit value, and neither limit value can be greater than 110% of the rated capacity. Press “ZERO” to adjust the value, touch “MODE” to shift to the next position. Press “LOG” to cancel; touch “MENU” to confirm and exit. (Figure 4-2h)

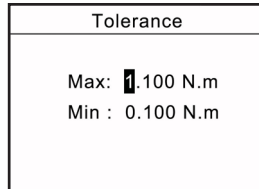

Figure 4-2h

4.2.6 Alarm

The alarm function can be turned on or off to activate or deactivate the user programmed tolerances set in the Tolerance Menu. Touch “ZERO” or “MODE” keys to shift to the next position. Press “LOG” to cancel, touch “MENU” to confirm and exit. (Figure 4-2i)

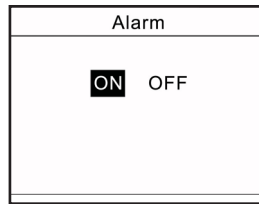

Figure 4-2i

4.2.7 Calibration

Users can field-calibrate the gauge. First, enter the system password (Default is 123) by pressing the “ZERO” and “MODE” keys. Then press “MENU” to confirm. (Figure 4-7a)

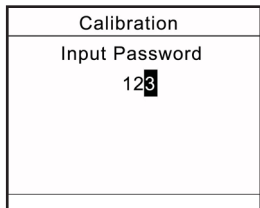

Figure 4-7a

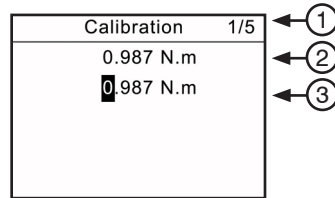

Figure 4-7b

- ① Calibration Point
- ② Current Value
- ③ Standard Input Value

Load a standard force on the gauge. Wait a moment for the force to stabilize. The current value (2) should equal the standard force applied.

If the values do not match, press “ZERO” and “MODE” keys to correct the standard input value (3).

Press “MENU” to enter the next calibration point. After any of the calibration points have been completed, touch “LOG” to exit the calibration mode. Then save the calibration or discard by pressing “Yes” or “No”.

After completing the calibration of the 5th point, the confirmation window will automatically ask to “Save and Exit” by selecting “Yes” or “No”. (Figure 4-7c)

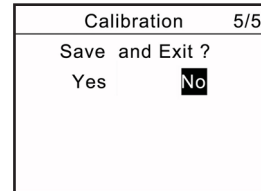

Figure 4-7c

Press “ZERO” or “MODE” to select, then press “MENU”. If “Yes” is selected, “Calibration Complete!” is displayed.

NOTE:

1. Ensure that the tare of attachment has been cleared before calibration.
2. For higher measuring precision throughout the test range, calibrating a point with a force at full scale is recommended.
3. Compression and tension calibrations are saved separately. The force gauge can identify the direction of the force, but each must be completed in a separate procedure.

4.3 Memory

In the Memory menu, the user can browse, delete, or print the data. (Figure 4-3a)

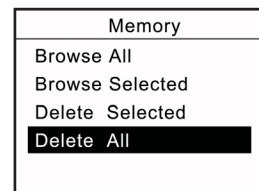

Figure 4-3a

4.3.2 Browse All

The data will be displayed. Touch “ZERO” or “MODE” keys to shift to the next position. Touch “MENU” to see Delete or Print options. Touch “LOG” to go back. (Fig. 4-3c)

No.	Torque	Dir
007	0.900 N.m	↶
008	0.534 N.m	↷
009	0.665 N.cm	↶
010	0.225 lbf.ft	↶

Figure 4-3c

4.3.4 Browse Selected

User can choose the data to browse. The available range of data stored is shown. Touch “ZERO” to adjust the value. Press “MODE” to shift to the next position. Press “LOG” to cancel; touch “MENU” to confirm. (Figure 4-3d)

Browse Selected
Range: 000~010
Select: 000~000

Figure 4-3d

4.3.5 Delete Selected

Select the range of data to be deleted. Touch “ZERO” to adjust the value. Press “MODE” to shift to the next position. Touch “LOG” to cancel; touch “MENU” to confirm. (Figure 4-3e)

Delete Selected
Range: 000~010
Select: 000~000

Figure 4-3e

4.3.6 Delete All

In this menu, a prompt will appear. All data will be deleted by selecting “YES” and canceled by selecting “NO” or pressing “LOG”. (Figure 4-3f)

Delete All
Confirm Delete?
Yes <input type="checkbox"/> No <input checked="" type="checkbox"/>

Figure 4-3f

4.4 Printing

The Printing menu contains three selectable items: Print Recent, Print Selected Print All and Print Diagram. (Figure 4-4a) The data saved in memory can be output to a printer through the serial port RS232 connection. (See 6.2.1 RS232 for more information) An example test report is shown in Figure 4-4b, 4-4c.

Printing
Print Recent
Print Selected
Print All
Print Diagram

Figure 4-4a

Test Report				
001	3.125	N*m	CCW	01
002	2.123	N*m	CCW	01
003	34.83	kgf*cm	CW	01
004	2.46	kgf*cm	CCW	02
005	25.05	lbf*ft	CW	02
Print Date: 2014-2-11				

Figure 4-4b

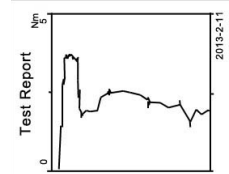

Figure 4-4c

4.4.1 Print Recent

Print recently stored data in this menu. The range is 0~19. (Figure 4-4c) Touch “ZERO” to adjust the value. Touch “MODE” to shift to the next position. Press “LOG” to cancel. Press “MENU” to confirm.

Print Recent
05 Data

Figure 4-4c

4.4.2 Print Selected

In this menu, select the data range to print. Touch “ZERO” to adjust the value, touch “MODE” to shift to the next position. Press “LOG” to cancel; touch “MENU” to confirm. (Figure 4-4d)

Print Selected
Range: 000~010
Select: 000~000

Figure 4-4d

4.4.3 Print All

To print all data saved in memory, a prompt window will display. All data will be printed by selecting “YES”. This operation will be canceled by selecting “NO” or touching “LOG”. (Figure 4-4e)

Print All
Confirm Print?
YES <input type="checkbox"/> NO <input checked="" type="checkbox"/>

Figure 4-4e

4.5 System

Under the System menu, several parameters may be set per Figure 4-5a, 4-5b.

System
Display Mode
Display Direction
Auto Power Off
Backlight
Key Tone

Figure 4-5a

System
Date/Time
Password
Key Setting
RS232 Baudrate
Default Setting

Figure 4-5b

4.5.1 Display Mode

Two display modes may be selected: Digital and Graphic (Figure 4-5c). If diagram is chosen, select the diagram's scale. (Figure 4-5d)

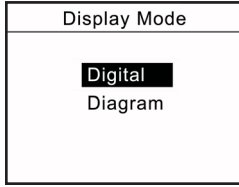

Figure 4-5c

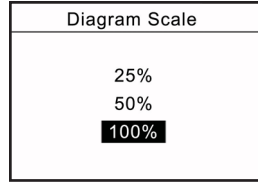

Figure 4-5d

4.5.2 Display Direction

Select the mode of the LCD display: Automatic, Obverse and Reverse. Touch "ZERO" or "MODE" keys to shift to the next position. Press "LOG" to cancel; Push "MENU" to confirm and exit. (Figure 4-5d)

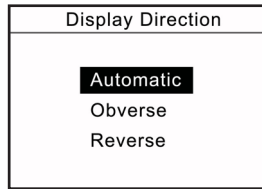

Figure 4-5e

4.5.3 Auto Power Off

To maximize battery life, the power can be set to shutdown after non-use. The time can be set in this menu. The range is 01-99 minutes. When set to "99" the gauge will never turn off. Touch "ZERO" to adjust the value, touch "MODE" to shift to the next position. Press "LOG" to cancel; Push "MENU" to confirm and exit. (Figure 4-5f)

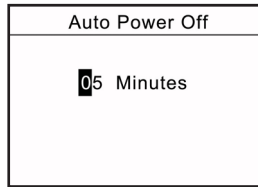

Figure 4-5f

4.5.4 Backlight

Under this menu, the backlight can be set to ON, OFF or have an auto shutdown. Touch "ZERO" or "MODE" keys to shift to the next position. Press "LOG" to cancel. Press "MENU" to confirm and exit. (Figure 4-5g)

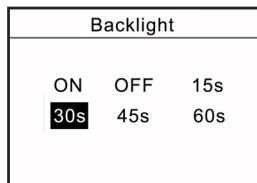

Figure 4-5g

4.5.5 Key Tone

Turn the key sound ON or OFF. Touch "ZERO" or "MODE" keys to shift to the next position. Touch "LOG" to cancel; Press "MENU" to confirm and exit. (Figure 4-5h)

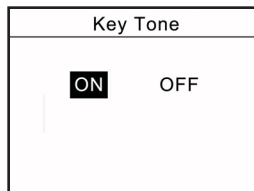

Figure 4-5h

4.5.6 Date/Time

The system time may be set under this menu. Touch "ZERO" to adjust the value. Press "MODE" to shift to the next position. Touch "LOG" to cancel. Press "MENU" to confirm and exit. (Figure 4-5i)

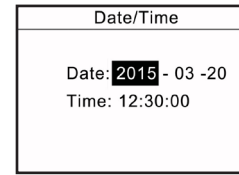

Figure 4-5i

4.5.7 Password

The system password can be changed. First, enter the old password (Figure 4-5j), then enter the new password and confirm the new password (Figure 4-5k). The default System password is "123". Touch "ZERO" to adjust the value. Press "MODE" to shift to the next position. Touch "LOG" to cancel; Push "MENU" to confirm and exit.

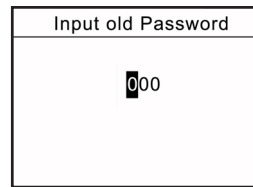

Figure 4-5j

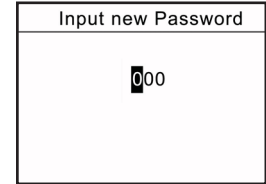

Figure 4-5k

4.5.8 Key Setting

Set the default function of the "LOG" key from the home screen. The function can be set to print or store the current displayed value. Press "ZERO" or "MODE" to select the proper setting. Press "LOG" to cancel; touch "MENU" to confirm and exit. (Figure 4-5l)

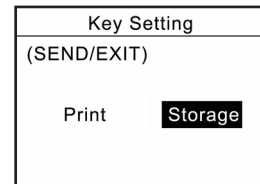

Figure 4-5l

4.5.9 RS232 Baurate

Adjust Baurate to available bits per second selection in Figure 4-5m.

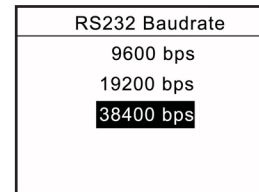

Figure 4-5m

4.5.10 Default Setting

If you make a selection that you feel has caused the gauge to operate improperly, you can restore it to the factory default settings. Carefully use this function! (Figure 4-5n, Figure 4-5o)

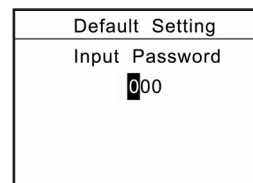

Figure 4-5l

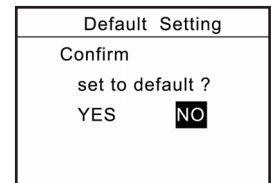

Figure 4-5o

4.6 Language

Select between English, German and Chinese (Figure 4-6a)



Figure 4-6a

4.8 Information

Information includes the model, version of the software and the serial number. (Figure 4-8a)

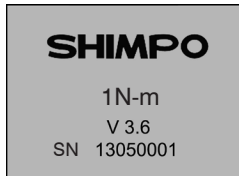

Figure 4-8a

5. CHARGING

The FG-7000T Series Digital Force Gauge is supplied with a set of 3 Nickel Metal Hydride AAA rechargeable batteries, which are supplied fully charged to allow immediate use. Users need to recharge batteries when a low battery icon flashes. Users should connect the gauge and the charger using the USB cable. Then connect the charger to an AC socket to start charging. Laptops and other USB devices can also charge the gauge. A fully charged battery pack will provide approximately 16 hours of constant use. Rechargeable battery pack:

- Type: Ni-MH 3.6VDC 800mAH rechargeable batteries
- Charging time: approx. 3~4 hours
- Battery life: approx. charge and discharge 500 times

6. COMMUNICATIONS

6.1 USB

The FG-7000T Series Digital Force Gauge is designed in accordance with USB2.0 standard protocol. (Figure 6-1a) The USB Port can be connected to a charger with the USB cable for charging the internal Ni-MH battery and can be connected to a computer for uploading the measured values. Connect the gauge and the computer with the USB cable, then open the computer software. Upload the values. Please refer to the software manual for additional information.

6.2 Port Pin Assignments

PIN#	Definition
1	RS232-Transmit
2	RS232-Receive
3	RS232-Ground
4	Comparison Output B
5	Reserved
6	Comparison Output C
7	Comparison Output A
8	Reserved

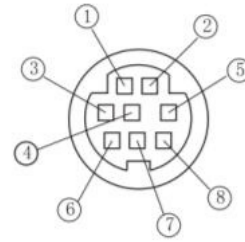

Figure 6-1a

6.2.1 RS232

The RS232 serial port is used to connect a printer to print the memory data.

RS-232 specifications are as follows:

- Data transmission: serial interface
- Synchronization: asynchronous
- Signal Level: RS-232 level, logic 1:-5v, logic 0: +5v
- Hardware Flow Control: None
- Data word length: 8 bits
- Stop bit: 1bit
- Parity: None
- Baud rate: 38400

6.2.2 Comparison Output

Comparison Output internal circuit shown as Figure 6-2a.

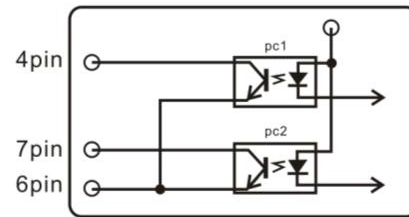
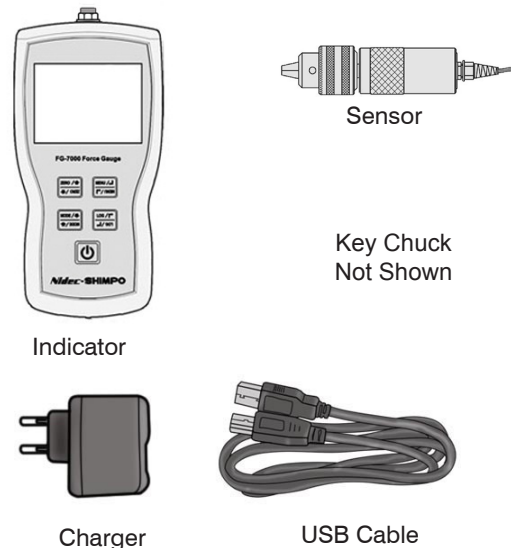

Figure 6-2a

When the measured value is less than the lower limit tolerance value, the "pc2" operates, 7pin and 6pin line conduction. When the measured value is more than the upper limit tolerance value or 110% of the rated capacity, the "pc1" operates, 4pin and 6pin line conduction. Maximum permissible voltage: 7pin to 6pin, 4pin to 6pin 35V; 6pin to 7pin, 6pin to 4pin 6V.

7. MISC.

7.1 Parts List



7.2 Diagram

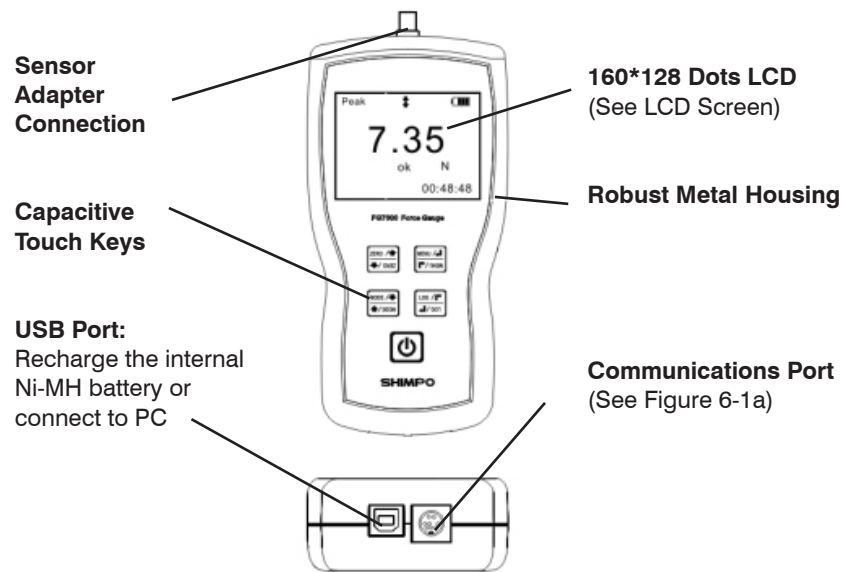

7.3 Dimensions

